



Internal Use Only

Website:<http://biz.LGservice.com>
E-mail:<http://www.LGService.com/techsup.html>

COLOR MONITOR SERVICE MANUAL

CHASSIS NO. : LM57G

MODEL: FLATRON W1942S(W1942S-PFT.A***QF)

()**Same model for Service

CAUTION

BEFORE SERVICING THE UNIT,
READ THE **SAFETY PRECAUTIONS** IN THIS MANUAL.

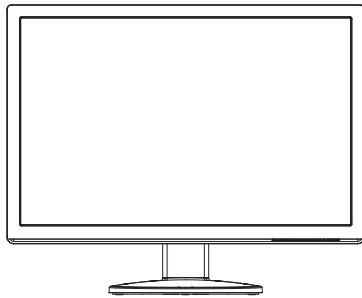

CONTENTS

SPECIFICATIONS	2	ADJUSTMENT	12
PRECAUTIONS	3	TROUBLESHOOTING GUIDE	14
TIMING CHART	7	WIRING DIAGRAM	18
DISASSEMBLY	8	EXPLODED VIEW	19
BLOCK DIAGRAM	9	REPLACEMENT PARTS LIST	21
DESCRIPTION OF BLOCK DIAGRAM.....	11	SCHEMATIC DIAGRAM.....	25

SPECIFICATIONS

1. LCD CHARACTERISTICS

Type : TFT Color LCD Module
 Active Display Area : 19 inch diagonal
 Pixel Pitch : 0.285 (H) x 0.285 (V)
 Size : 428(H) x 278(V) x 18.5(D)
 Color Depth : 16.7M(8bit + FRC) colors
 Electrical Interface : LVDS
 Surface Treatment : Anti-Glare, Hard Coating(3H)
 Operating Mode : Transmissive mode, Normally White
 Backlight Unit : 4 CCFL

2. OPTICAL CHARACTERISTICS

2-1. Viewing Angle by Contrast Ratio ≥ 10

Left : -85°(Typ) Right : +85°(Typ)
 Top : +85°(Typ) Bottom : +85°(Typ)

2-2. Luminance : 180(Typ) (Typ. ± 30)
 : 250(min), 300(Typ)-**6500K**
 : 150(min)-**9300K**

2-3. Contrast Ratio : 8000(min)
 DFC -> 5000 : 1(Typ)

3. SIGNAL (Refer to the Timing Chart)

3-1. Sync Signal
 • Type : Separate Sync, SOG

3-2. Video Input Signal

1) Type : R, G, B Analog
 2) Voltage Level : 0~0.71 V
 a) Color 0, 0 : 0 Vp-p
 b) Color 7, 0 : 0.467 Vp-p
 c) Color 15, 0 : 0.714 Vp-p
 3) Input Impedance : 75 Ω

3-3. Operating Frequency

Horizontal : 30 ~ 83kHz
 Vertical : 56 ~ 75Hz

4. MAX. RESOLUTION

Analog : 1440 x 900@75Hz

5. POWER SUPPLY

5-1. Power Adaptor(Built-in Power)
 Input : AC 100-240V~, 50/60Hz, 0.8A

5-2. Power Consumption

MODE	H/V SYNC	VIDEO	POWER CONSUMPTION	LED COLOR
POWER ON (NORMAL)	ON/ON	ACTIVE	less than 39 W(max)	BLUE
			less than 36 W(typ)	
STAND BY	OFF/ON	OFF	less than 1 W	AMBER
SUSPEND	ON/OFF	OFF	less than 1 W	AMBER
DPMS OFF	OFF/OFF	OFF	less than 1 W	AMBER
POWER S/W OFF	-	-	less than 1 W	OFF

6. ENVIRONMENT

6-1. Operating Temperature : 10°C~35°C (50°F~95°F)
 6-2. Relative Humidity : 10%~80% (Non-condensing)
 6-3. MTBF : 50,000 HRS with 90%
 Confidence level
 Lamp Life : 40,000 Hours (Min)

7. DIMENSIONS (with TILT/SWIVEL)

Width : 448.4 mm (17.65")
 Depth : 198.4 mm (7.81")
 Height : 383.3 mm (15.09")

8. WEIGHT (with TILT/SWIVEL)

Net. Weight : 3.25 kg (7.22 lbs)
 Gross Weight : 4.55 kg (10.11 lbs)

PRECAUTION

WARNING FOR THE SAFETY-RELATED COMPONENT.

- There are some special components used in LCD monitor that are important for safety. **These parts are marked \triangle on the schematic diagram and the replacement parts list.** It is essential that these critical parts should be replaced with the manufacturer's specified parts to prevent electric shock, fire or other hazard.
- Do not modify original design without obtaining written permission from manufacturer or you will void the original parts and labor guarantee.

TAKE CARE DURING HANDLING THE LCD MODULE WITH BACKLIGHT UNIT.

- Must mount the module using mounting holes arranged in four corners.
- Do not press on the panel, edge of the frame strongly or electric shock as this will result in damage to the screen.
- Do not scratch or press on the panel with any sharp objects, such as pencil or pen as this may result in damage to the panel.
- Protect the module from the ESD as it may damage the electronic circuit (C-MOS).
- Make certain that treatment person's body are grounded through wrist band.
- Do not leave the module in high temperature and in areas of high humidity for a long time.
- The module not be exposed to the direct sunlight.
- Avoid contact with water as it may a short circuit within the module.
- If the surface of panel become dirty, please wipe it off with a softmaterial. (Cleaning with a dirty or rough cloth may damage the panel.)

\triangle CAUTION

Please use only a plastic screwdriver to protect yourself from shock hazard during service operation.

\triangle WARNING

BE CAREFUL ELECTRIC SHOCK !

- If you want to replace with the new backlight (CCFL) or inverter circuit, must disconnect the AC adapter because high voltage appears at inverter circuit about 650Vrms.
- Handle with care wires or connectors of the inverter circuit. If the wires are pressed cause short and may burn or take fire.

Leakage Current Hot Check Circuit

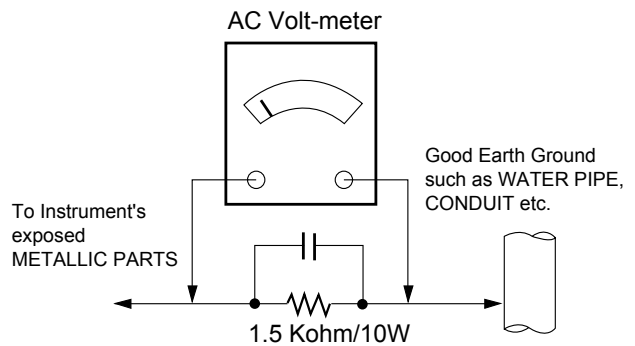

SERVICING PRECAUTIONS

CAUTION: Before servicing receivers covered by this service manual and its supplements and addenda, read and follow the **SAFETY PRECAUTIONS** on page 3 of this publication.

NOTE: If unforeseen circumstances create conflict between the following servicing precautions and any of the safety precautions on page 3 of this publication, always follow the safety precautions. Remember: Safety First.

General Servicing Precautions

1. Always unplug the receiver AC power cord from the AC power source before;
 - a. Removing or reinstalling any component, circuit board module or any other receiver assembly.
 - b. Disconnecting or reconnecting any receiver electrical plug or other electrical connection.
 - c. Connecting a test substitute in parallel with an electrolytic capacitor in the receiver.

CAUTION: A wrong part substitution or incorrect polarity installation of electrolytic capacitors may result in an explosion hazard.

- d. Discharging the picture tube anode.
2. Test high voltage only by measuring it with an appropriate high voltage meter or other voltage measuring device (DVM, FETVOM, etc) equipped with a suitable high voltage probe.
Do not test high voltage by "drawing an arc".
 3. Discharge the picture tube anode only by (a) first connecting one end of an insulated clip lead to the degaussing or kine aquadag grounding system shield at the point where the picture tube socket ground lead is connected, and then (b) touch the other end of the insulated clip lead to the picture tube anode button, using an insulating handle to avoid personal contact with high voltage.
 4. Do not spray chemicals on or near this receiver or any of its assemblies.
 5. Unless specified otherwise in this service manual, clean electrical contacts only by applying the following mixture to the contacts with a pipe cleaner, cotton-tipped stick or comparable non-abrasive applicator; 10% (by volume) Acetone and 90% (by volume) isopropyl alcohol (90%-99% strength)

CAUTION: This is a flammable mixture.

Unless specified otherwise in this service manual, lubrication of contacts is not required.

6. Do not defeat any plug/socket B+ voltage interlocks with which receivers covered by this service manual might be equipped.
7. Do not apply AC power to this instrument and/or any of its electrical assemblies unless all solid-state device heat sinks are correctly installed.
8. Always connect the test receiver ground lead to the receiver chassis ground before connecting the test receiver positive lead.

Always remove the test receiver ground lead last.

9. Use with this receiver only the test fixtures specified in this service manual.

CAUTION: Do not connect the test fixture ground strap to any heat sink in this receiver.

Electrostatically Sensitive (ES) Devices

Some semiconductor (solid-state) devices can be damaged easily by static electricity. Such components commonly are called *Electrostatically Sensitive (ES) Devices*. Examples of typical ES devices are integrated circuits and some field-effect transistors and semiconductor "chip" components. The following techniques should be used to help reduce the incidence of component damage caused by static by static electricity.

1. Immediately before handling any semiconductor component or semiconductor-equipped assembly, drain off any electrostatic charge on your body by touching a known earth ground. Alternatively, obtain and wear a commercially available discharging wrist strap device, which should be removed to prevent potential shock reasons prior to applying power to the unit under test.
2. After removing an electrical assembly equipped with ES devices, place the assembly on a conductive surface such as aluminum foil, to prevent electrostatic charge buildup or exposure of the assembly.
3. Use only a grounded-tip soldering iron to solder or unsolder ES devices.
4. Use only an anti-static type solder removal device. Some solder removal devices not classified as "anti-static" can generate electrical charges sufficient to damage ES devices.
5. Do not use freon-propelled chemicals. These can generate electrical charges sufficient to damage ES devices.
6. Do not remove a replacement ES device from its protective package until immediately before you are ready to install it. (Most replacement ES devices are packaged with leads electrically shorted together by conductive foam, aluminum foil or comparable conductive material).
7. Immediately before removing the protective material from the leads of a replacement ES device, touch the protective material to the chassis or circuit assembly into which the device will be installed.

CAUTION: Be sure no power is applied to the chassis or circuit, and observe all other safety precautions.

8. Minimize bodily motions when handling unpackaged replacement ES devices. (Otherwise harmless motion such as the brushing together of your clothes fabric or the lifting of your foot from a carpeted floor can generate static electricity sufficient to damage an ES device.)

General Soldering Guidelines

1. Use a grounded-tip, low-wattage soldering iron and appropriate tip size and shape that will maintain tip temperature within the range of 500° F to 600° F.
2. Use an appropriate gauge of RMA resin-core solder composed of 60 parts tin/40 parts lead.
3. Keep the soldering iron tip clean and well tinned.
4. Thoroughly clean the surfaces to be soldered. Use a small wire-bristle (0.5 inch, or 1.25cm) brush with a metal handle.

Do not use freon-propelled spray-on cleaners.

5. Use the following unsoldering technique
 - a. Allow the soldering iron tip to reach normal temperature.
(500° F to 600° F)
 - b. Heat the component lead until the solder melts.
 - c. Quickly draw the melted solder with an anti-static, suction-type solder removal device or with solder braid.
6. Use the following soldering technique.
 - a. Allow the soldering iron tip to reach a normal temperature (500° F to 600° F)
 - b. First, hold the soldering iron tip and solder the strand against the component lead until the solder melts.

- c. Quickly move the soldering iron tip to the junction of the component lead and the printed circuit foil, and hold it there only until the solder flows onto and around both the component lead and the foil.

CAUTION: Work quickly to avoid overheating the circuit board printed foil.

- d. Closely inspect the solder area and remove any excess or splashed solder with a small wire-bristle brush.

IC Remove/Replacement

Some chassis circuit boards have slotted holes (oblong) through which the IC leads are inserted and then bent flat against the circuit foil. When holes are the slotted type, the following technique should be used to remove and replace the IC. When working with boards using the familiar round hole, use the standard technique as outlined in paragraphs 5 and 6 above.

Removal

1. Desolder and straighten each IC lead in one operation by gently prying up on the lead with the soldering iron tip as the solder melts.
2. Draw away the melted solder with an anti-static suction-type solder removal device (or with solder braid) before removing the IC.

Replacement

1. Carefully insert the replacement IC in the circuit board.
2. Carefully bend each IC lead against the circuit foil pad and solder it.
3. Clean the soldered areas with a small wire-bristle brush. (It is not necessary to reapply acrylic coating to the areas).

"Small-Signal" Discrete Transistor

Removal/Replacement

1. Remove the defective transistor by clipping its leads as close as possible to the component body.
2. Bend into a "U" shape the end of each of three leads remaining on the circuit board.
3. Bend into a "U" shape the replacement transistor leads.
4. Connect the replacement transistor leads to the corresponding leads extending from the circuit board and crimp the "U" with long nose pliers to insure metal to metal contact then solder each connection.

Power Output, Transistor Device

Removal/Replacement

1. Heat and remove all solder from around the transistor leads.
2. Remove the heat sink mounting screw (if so equipped).
3. Carefully remove the transistor from the heat sink of the circuit board.
4. Insert new transistor in the circuit board.
5. Solder each transistor lead, and clip off excess lead.
6. Replace heat sink.

Diode Removal/Replacement

1. Remove defective diode by clipping its leads as close as possible to diode body.
2. Bend the two remaining leads perpendicular y to the circuit board.
3. Observing diode polarity, wrap each lead of the new diode around the corresponding lead on the circuit board.
4. Securely crimp each connection and solder it.
5. Inspect (on the circuit board copper side) the solder joints of the two "original" leads. If they are not shiny, reheat them and if necessary, apply additional solder.

Fuse and Conventional Resistor

Removal/Replacement

1. Clip each fuse or resistor lead at top of the circuit board hollow stake.
2. Securely crimp the leads of replacement component around notch at stake top.
3. Solder the connections.

CAUTION: Maintain original spacing between the replaced component and adjacent components and the circuit board to prevent excessive component temperatures.

Circuit Board Foil Repair

Excessive heat applied to the copper foil of any printed circuit board will weaken the adhesive that bonds the foil to the circuit board causing the foil to separate from or "lift-off" the board. The following guidelines and procedures should be followed whenever this condition is encountered.

At IC Connections

To repair a defective copper pattern at IC connections use the following procedure to install a jumper wire on the copper pattern side of the circuit board. (Use this technique only on IC connections).

1. Carefully remove the damaged copper pattern with a sharp knife. (Remove only as much copper as absolutely necessary).
2. Carefully scratch away the solder resist and acrylic coating (if used) from the end of the remaining copper pattern.
3. Bend a small "U" in one end of a small gauge jumper wire and carefully crimp it around the IC pin. Solder the IC connection.
4. Route the jumper wire along the path of the out-away copper pattern and let it overlap the previously scraped end of the good copper pattern. Solder the overlapped area and clip off any excess jumper wire.

At Other Connections

Use the following technique to repair the defective copper pattern at connections other than IC Pins. This technique involves the installation of a jumper wire on the component side of the circuit board.

1. Remove the defective copper pattern with a sharp knife.
Remove at least 1/4 inch of copper, to ensure that a hazardous condition will not exist if the jumper wire opens.
2. Trace along the copper pattern from both sides of the pattern break and locate the nearest component that is directly connected to the affected copper pattern.
3. Connect insulated 20-gauge jumper wire from the lead of the nearest component on one side of the pattern break to the lead of the nearest component on the other side.
Carefully crimp and solder the connections.

CAUTION: Be sure the insulated jumper wire is dressed so the it does not touch components or sharp edges.

TIMING CHART

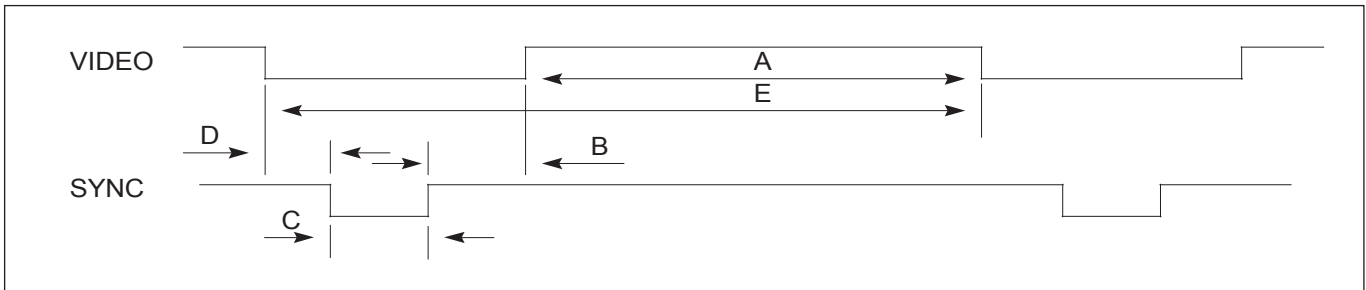

MODE	H / V	Sync Polarity	Dot Clock	Frequency	Total Period (E)	Video Active Time (A)	Sync Duration (D)	Front Porch (C)	Blanking Time (B)	Resolution
1	H(Pixels)	+	25.175	31.469	800	640	16	96	48	640 x 350
	V(Lines)	-		70.09						
2	H(Pixels)	-	28.321	31.468	900	720	18	108	54	720 X 400
	V(Lines)	+		70.08						
3	H(Pixels)	-	25.175	31.469	800	640	16	96	48	640 x 480
	V(Lines)	-		59.94						
4	H(Pixels)	-	31.5	37.5	840	640	16	64	120	640 x 480
	V(Lines)	-		75						
5	H(Pixels)	+	40.0	37.879	1056	800	40	128	88	800 x 600
	V(Lines)	+		60.317						
6	H(Pixels)	+	49.5	46.875	1056	800	16	80	160	800 x 600
	V(Lines)	+		75.0						
7	H(Pixels)	+/-	57.283	49.725	1152	832	32	64	224	832 x 624
	V(Lines)	+/-		74.55						
8	H(Pixels)	-	65.0	48.363	1344	1024	24	136	160	1024 x 768
	V(Lines)	-		60.0						
9	H(Pixels)	-	78.75	60.123	1312	1024	16	96	176	1024 x 768
	V(Lines)	-		75.029						
10	H(Pixels)	+/-	100.0	68.681	1456	1152	32	128	144	1152 x 870
	V(Lines)	+/-		75.062						
11	H(Pixels)	+/-	92.978	61.805	1504	1152	18	134	200	1152 x 900
	V(Lines)	+/-		65.96						
12	H(Pixels)	+	108.0	63.981	1688	1280	48	112	248	1280 x 1024
	V(Lines)	+		60.02						
13	H(Pixels)	+	135.0	79.976	1688	1280	16	144	248	1280 X 1024
	V(Lines)	+		75.035						
14	H(Pixels)	+	88.750	55.5	1600	1440	48	32	80	1440 x 900
	V(Lines)	-		59.90						
15	H(Pixels)	-	106.500	55.935	1904	1440	80	152	232	1440x 900
	V(Lines)	+		59.887						
16	H(Pixels)	-	136.750	70.635	1936	1440	96	152	248	1440x 900
	V(Lines)	+		74.984						

DISASSEMBLY

1



Pull the cabinet upwards,
Then push the button "push" to separate
the hinge body and stand body.

2

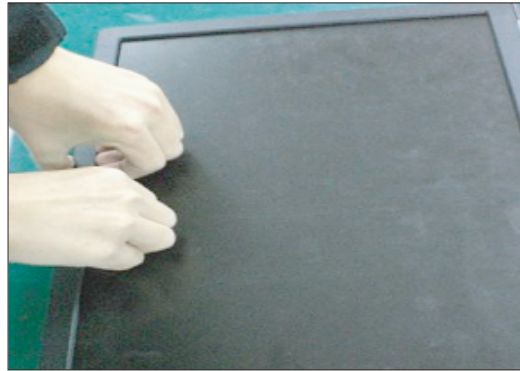

Pull the cabinet upwards,
Then separate all latches on each side.

3



Disassemble the back cover.

4

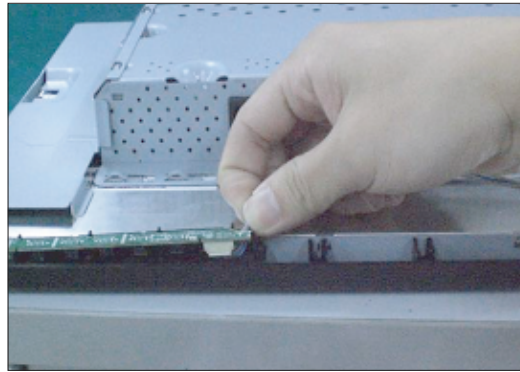

Remove the control button from cabinet,
Then disassemble the connector.

5

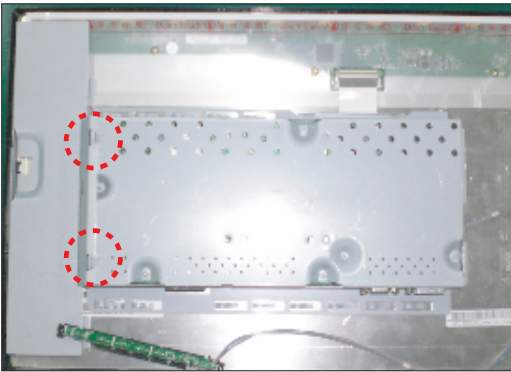

Separate the lamp shield from rear shield.
Please pull off the latch first.

6



Turn around the base lock to open the
lock between base cover and stand body..

7



Then separate stand body and base cover.

BLOCK DIAGRAM

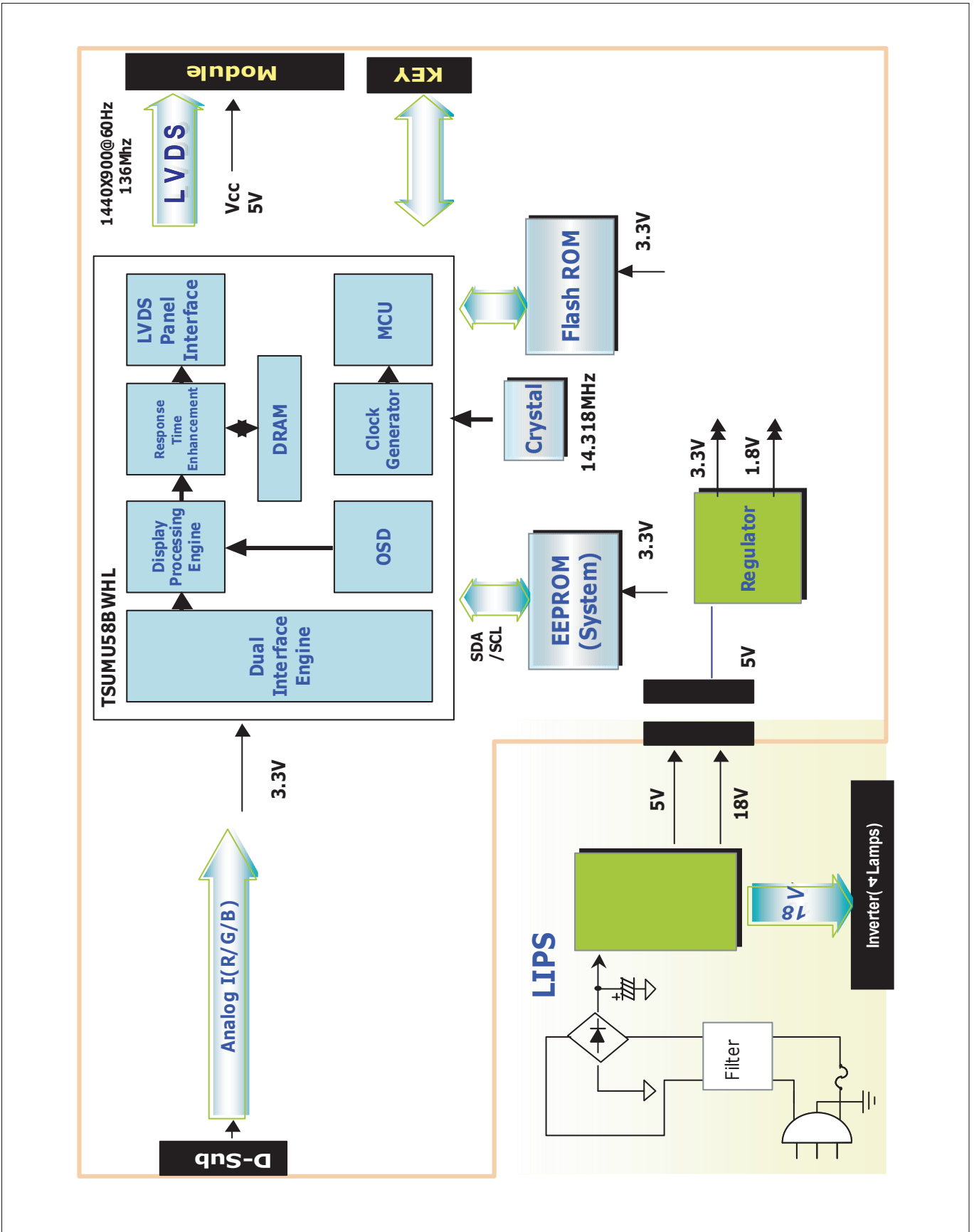

DESCRIPTION OF BLOCK DIAGRAM

1. Video Controller Part.

This part amplifies the level of video signal for the digital conversion and converts from the analog video signal to the digital video signal using a pixel clock.

The pixel clock for each mode is generated by the PLL.

The range of the pixel clock is from 25MHz to 136MHz in W1942S case(28MHz to 146MHz In W1942S CASE).

This part consists of the Scaler, ADC convertor, TMDS receiver and LVDS transmitter.

The Scaler gets the video signal converted analog to digital, interpolates input to 1440 X 900 resolution signal and outputs 8-bit R, G, B signal to transmitter.

2. Power Part.

This part consists of the one 3.3V, and one 1.8V regulators to convert power which is provided 5V in Power board. 18V is provided for inverter, 5V is provided for LCD panel and micom in W1942S case .

Also, 5V is converted 3.3V and 1.8V by regulator. Converted power is provided for IC in the main board.

The inverter converts from DC18V to AC 700Vrms and operates back-light lamps of module in W1942S case.

3. MICOM Part.

This part is include video controller part. And this part consists of EEPROM IC which stores control data, Reset IC and the Micom.

The Micom distinguishes polarity and frequency of the H/V sync are supplied from signal cable.

The controlled data of each modes is stored in EEPROM.

LIPS Board Block Diagram

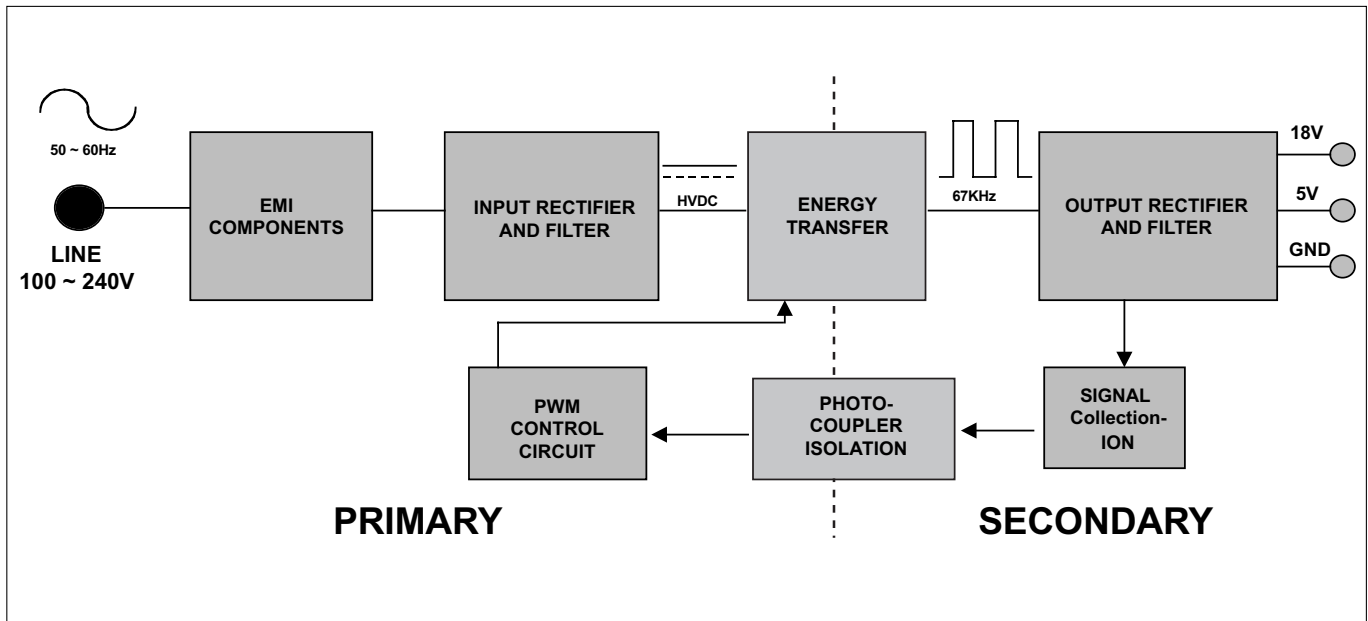

Operation description_Power

1. EMI components.

This part contains of EMI components to comply with global marketing EMI standards like FCC,VCCI CISPR, the circuit included a line-filter, across line capacitor and of course the primary protection fuse.

2. Input rectifier and filter.

This part function is for transfer the input AC voltage to a DC voltage through a bridge rectifier and a bulk capacitor.

3. Energy Transfer.

This part function is for transfer the primary energy to secondary through a power transformer.

4. Output rectifier and filter.

This part function is to make a pulse width modulation control and to provide the driver signal to power switch, to adjust the duty cycle during different AC input and output loading condition to achieve the dc output stabilized, and also the over power protection is also monitor by this part.

5. Photo-Coupler isolation.

This part function is to feed back the DC output changing status through a photo transistor to primary controller to achieve the stabilized DC output voltage.

6. Signal collection.

This part function is to collect the any change from the DC output and feed back to the primary through photo transistor.

ADJUSTMENT

Windows EDID V1.0 User Manual

Operating System: MS Windows 98, 2000, XP
 Port Setup: Windows 98 => Doesn't need setup
 Windows 2000, XP => Need to Port Setup.

This program is available for LCD Monitor only.

1. Port Setup

- a) Copy "UserPort.sys" file to "c:\WINNT\system32\drivers" folder
- b) Run Userport.exe

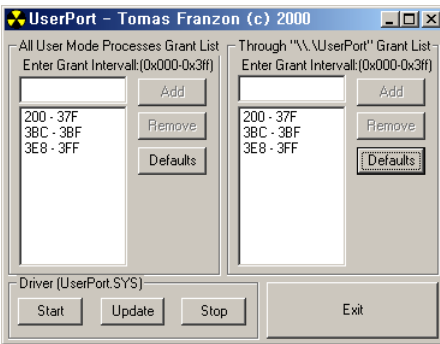

- c) Remove all default number
- d) Add 300-3FF

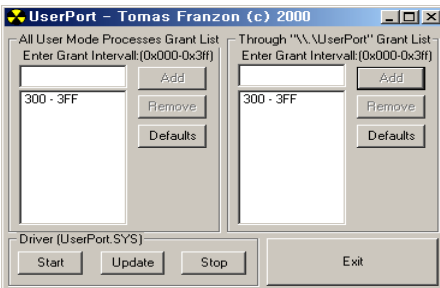

- e) Click Start button.
- f) Click Exit button.

2. EDID Read & Write

1) Run WinEDID.exe

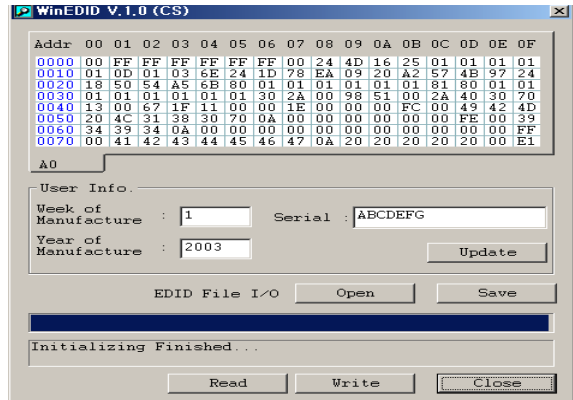

2) Edit Week of Manufacture, Year of Manufacture, Serial Number

- a) Input User Info Data
- b) Click "Update" button
- c) Click "Write" button

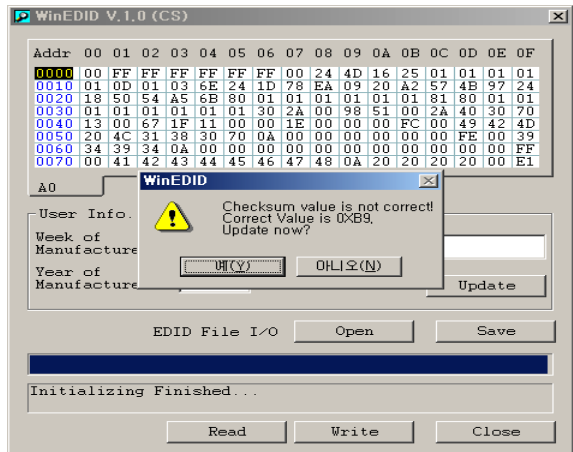

SERVICE OSD

- 1) Turn off the power switch at the right side of the display.
- 2) Wait for about 5 seconds and press MENU, POWER switch for 1 second interval.
- 3) The SVC OSD menu contains additional menus that the User OSD menu as described below.
 - a) CLEAR ETI : To initialize using time.
 - c) Auto Color : W/B balance and Automatically sets the gain and offset value.
(press key for over 3 sec)
 - d) AGING : Select Aging mode(on/off).
 - b) Module : To select applied module.
 - d) NVRAM INIT : EEPROM initialize.(24C16, press key for over 3 sec)
 - e) R/G/B-9300K : Allows you to set the R/G/B-9300K value manually.
 - f) R/G/B-6500K : Allows you to set the R/G/B-6500K value manually.
 - g) R/G/B-Offset : Allows you to set the R/G/B-Offset value manually.(Analog Only)
 - h) R/G/B-Gain : Allows you to set the R/G/B-Gain value manually.(Analog Only)

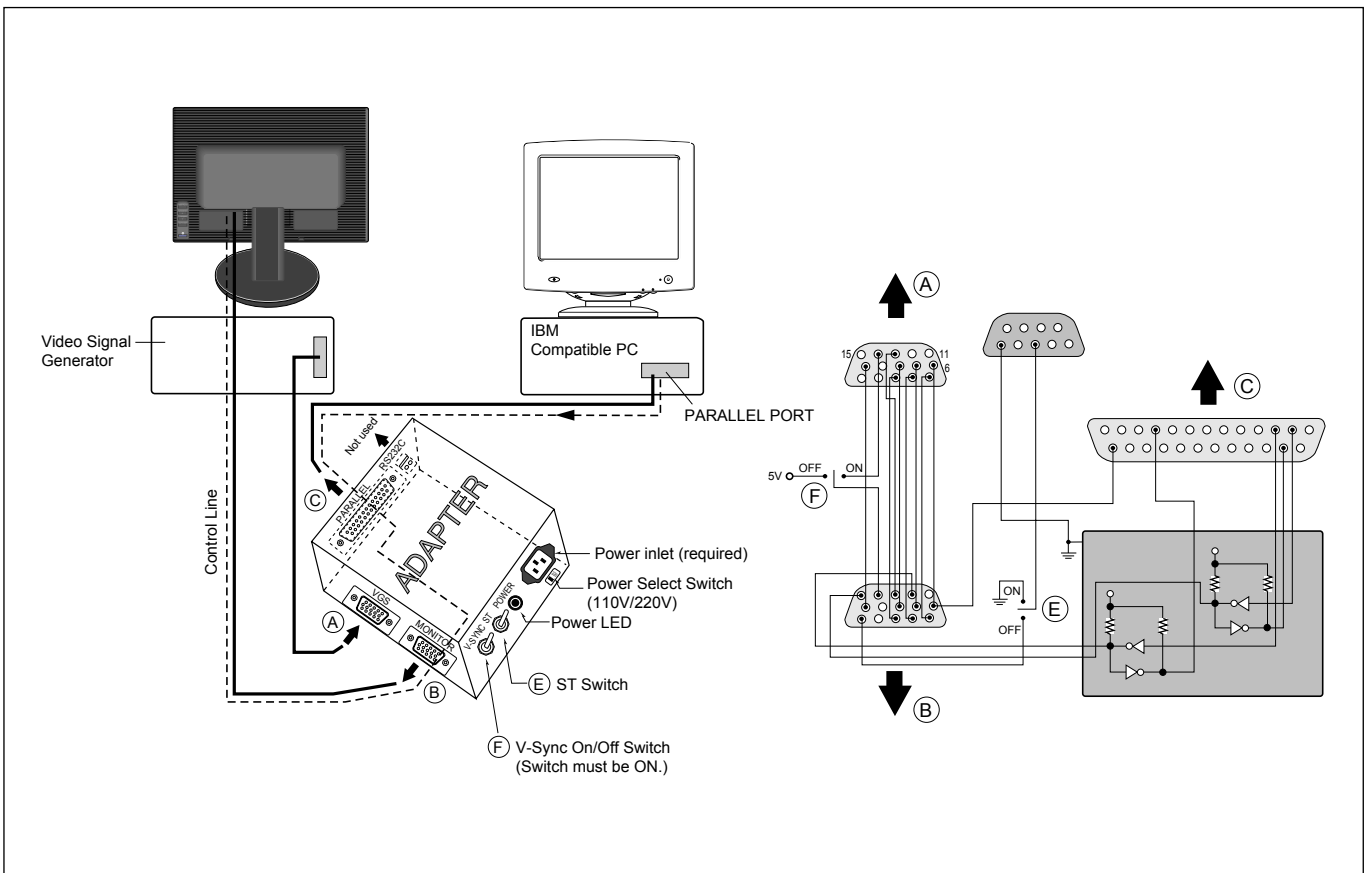
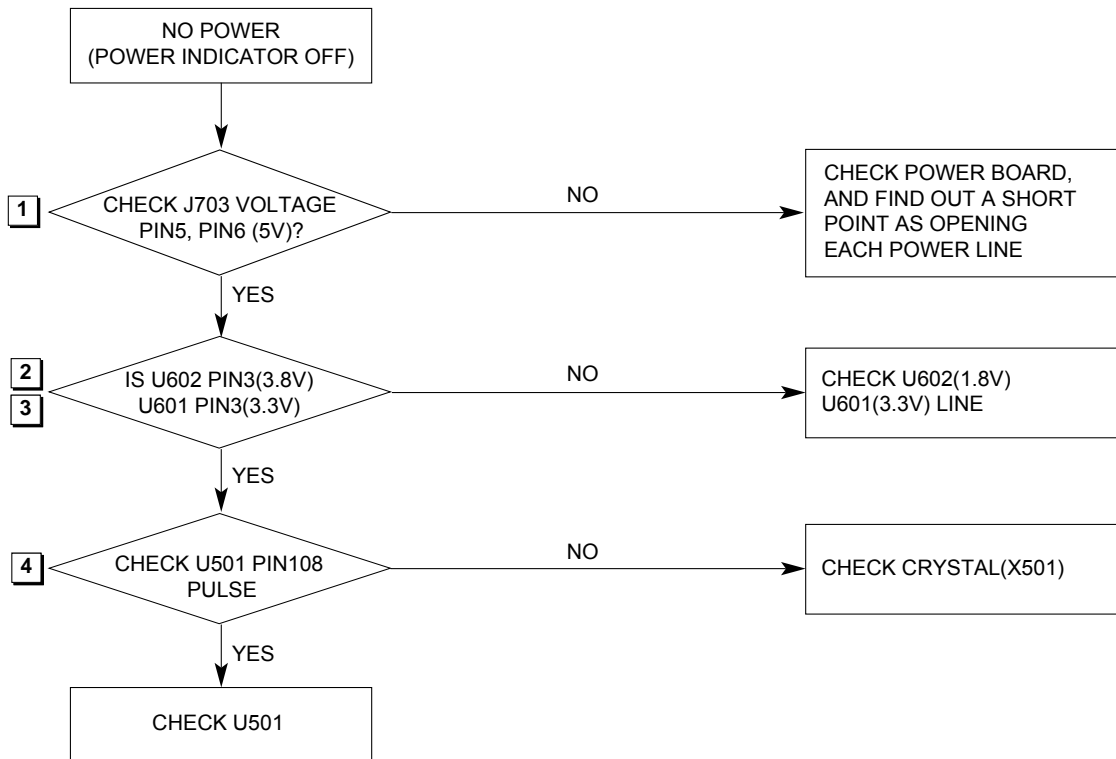

Figure 1. Cable Connection

TROUBLESHOOTING GUIDE

1. NO POWER



Waveforms

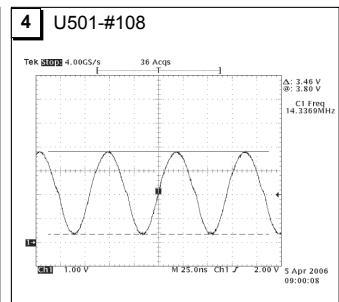
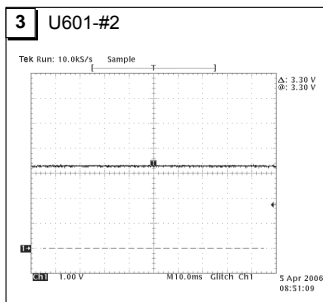
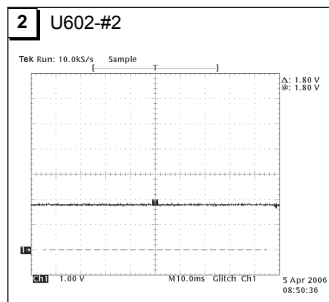
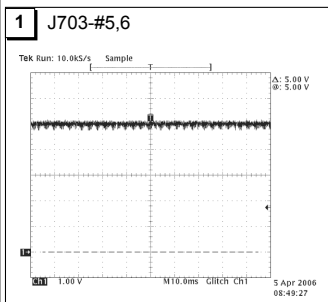

2. NO RASTER (OSD IS NOT DISPLAYED) – LIPS

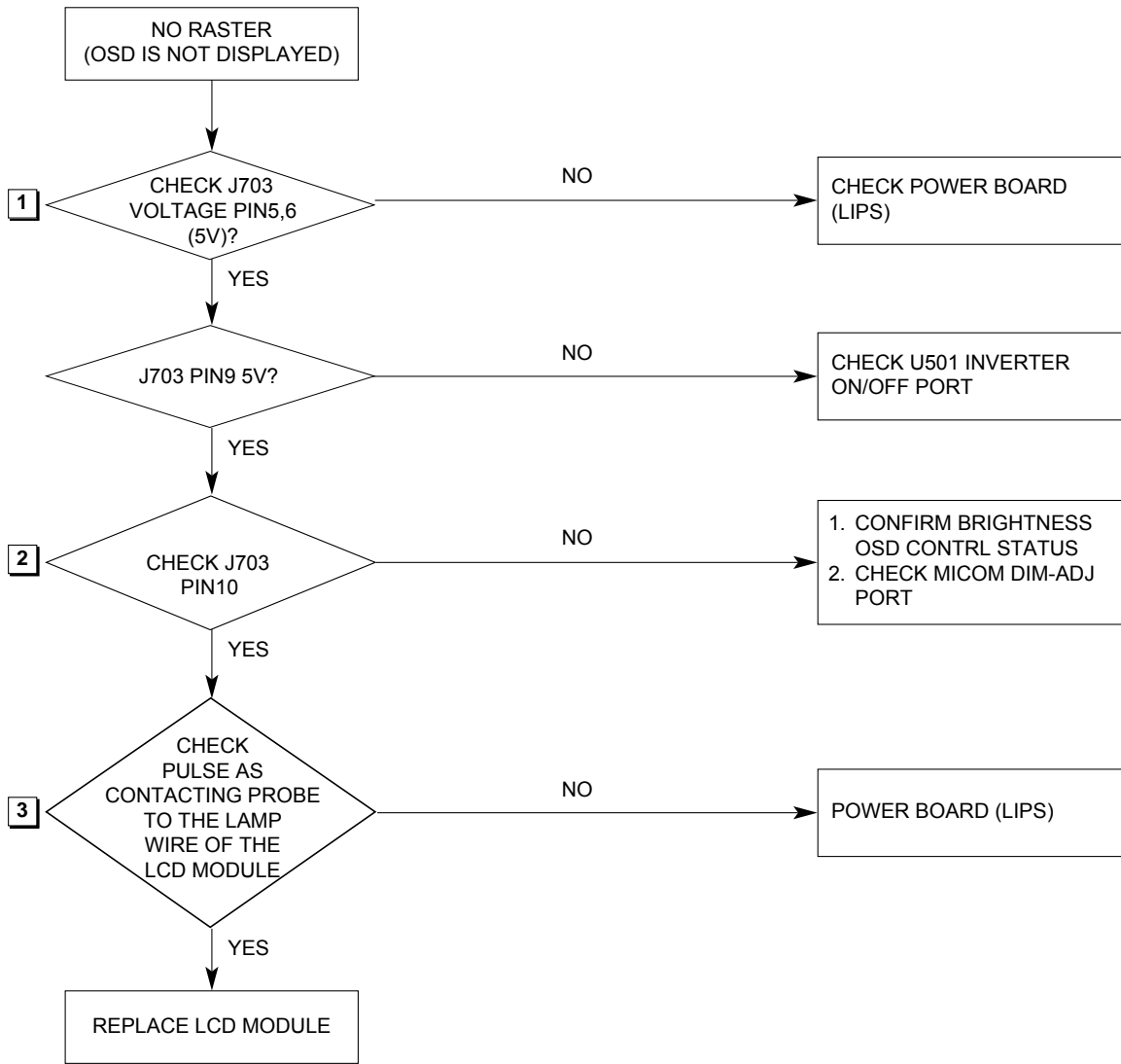

Waveforms

1 J703-#5,6

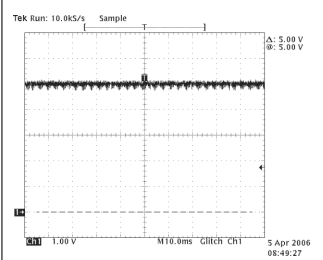

2 J703-#10

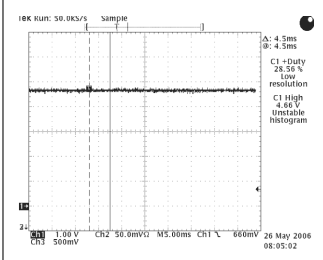

3 LAMP CURRENT

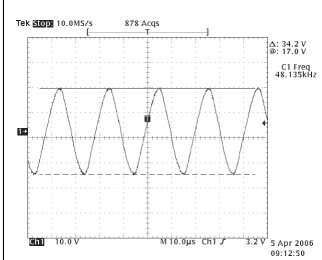

3. NO RASTER (OSD IS NOT DISPLAYED) - MAIN

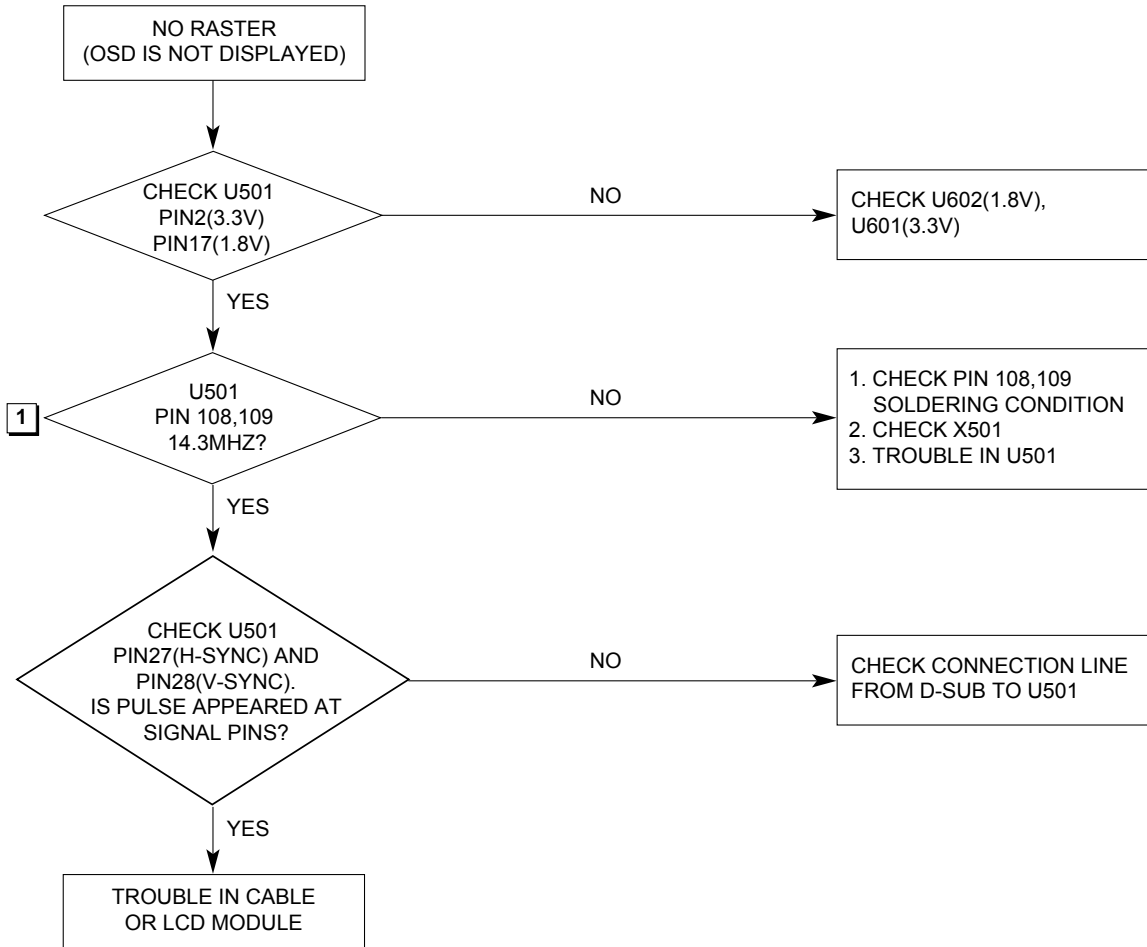

Waveforms

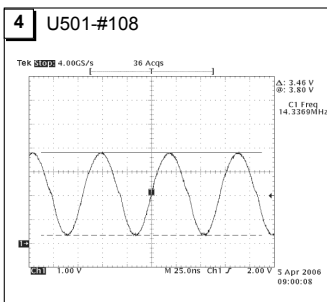

4. TROUBLE IN DPM

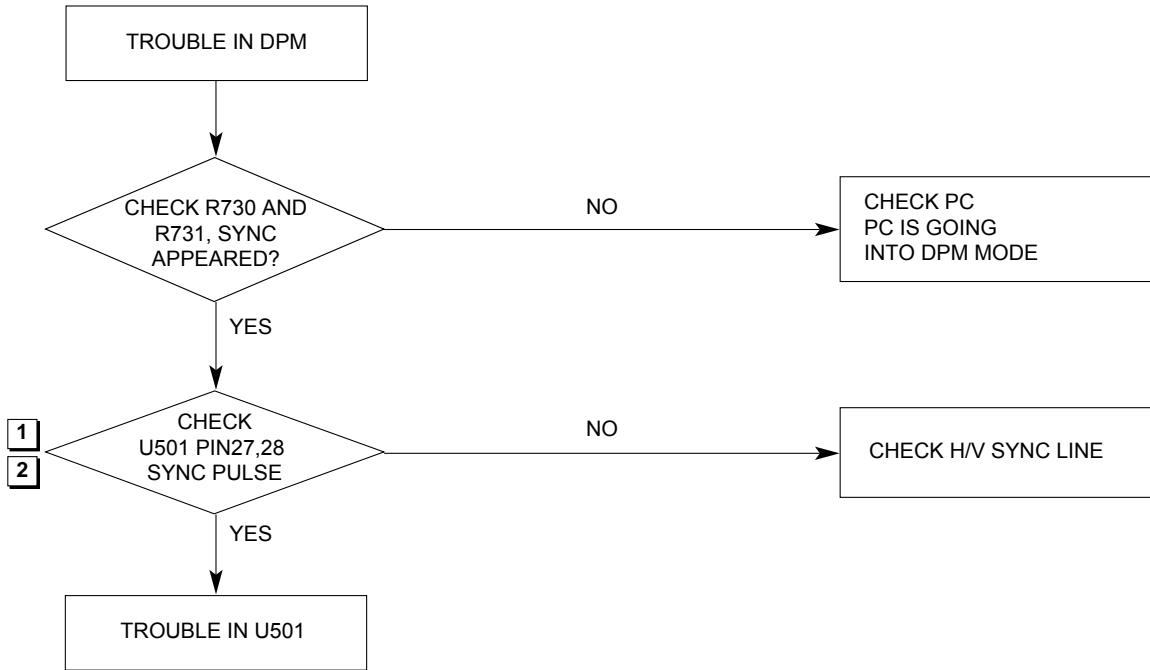

Waveforms

1 H-SYNC

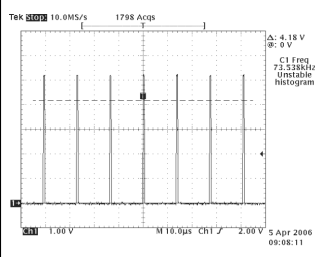

2 V-SYNC

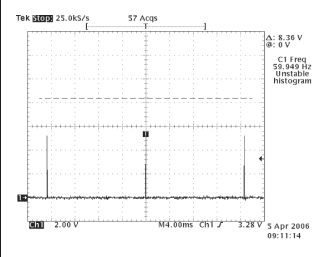

WIRING DIAGRAM

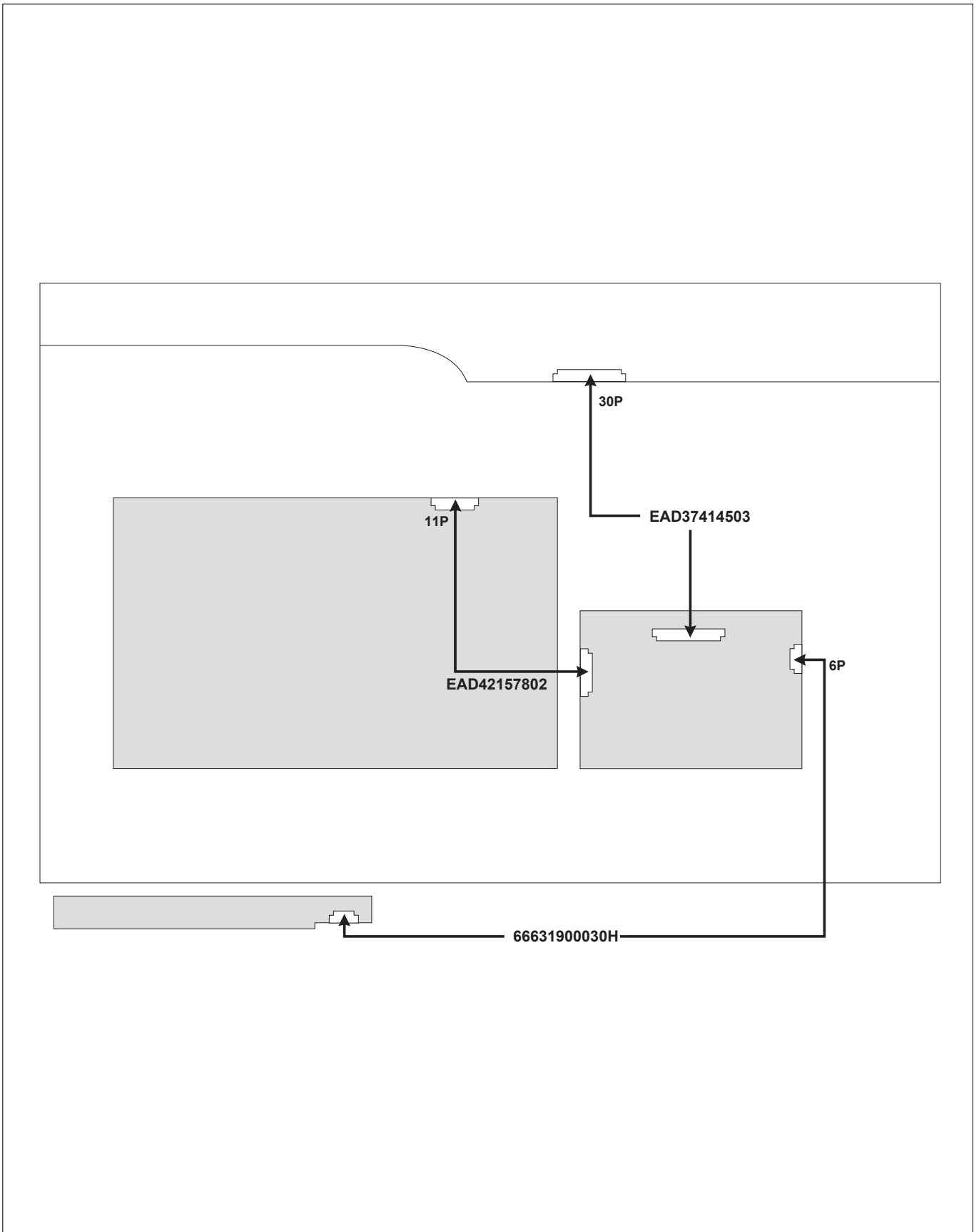

EXPLODED VIEW

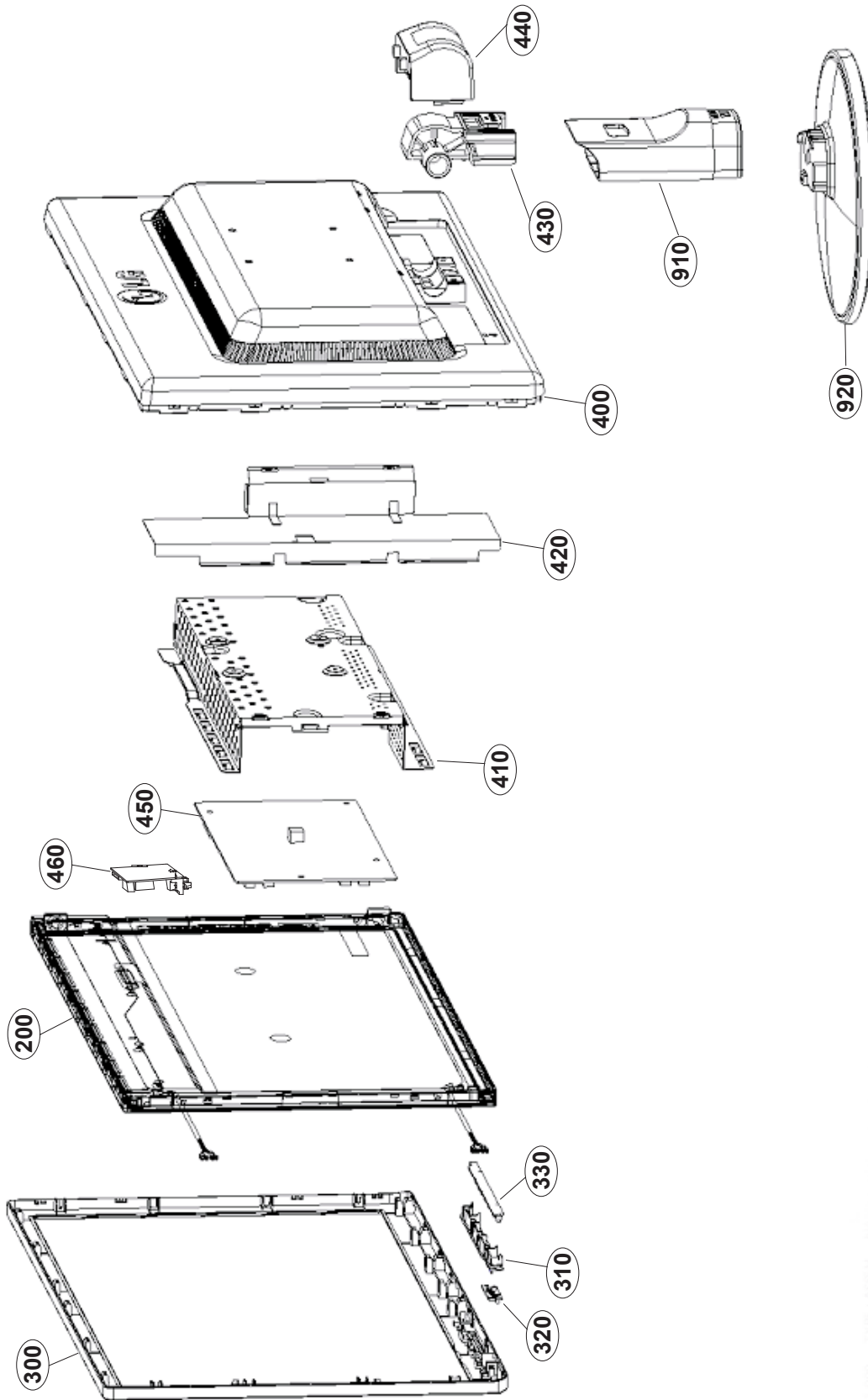

EXPLODED VIEW PARTS LIST

* Note: Safety mark

Ref. No.	Part No.	Description
300	△ ABJ37045301	Cabinet Assembly,W1942T W1942 19" W1942T AUO/BOE/NEC/HSD DUAL HIGH GLOSSY CABINET ASSY
310	△ MEY40926601	Knob, MOLD ABS HF-350 MAIN 5 key WX42 BLACK
320	△ MBG41956001	Button,Power, MOLD ABS WX42 translucent ABS power button + lens
400	ACQ35578202	Cover Assembly,Rear, W1942 WX42 19" W1942 LPL BACK COVER ASM ANALOG
	ACQ35578204	Cover Assembly,Rear, W1942 WX42 19" W1942 AUO/ BOE BACK COVER ASM ANALOG
	ACQ35578206	Cover Assembly,Rear, W1942 WX42 19" W1942 COM BACK COVER ASM ANALOG
410	MDQ41956301	Frame, PRESS SBHG 0.8 W1942,W2042 SBHG rear shield analog
420	MDQ41956801	Frame, PRESS SBHG 0.6 W1942 SBHG lamp shield
430	MCK40926801	Cover, MOLD ABS HF-350 Wx42 ABS Hinge body
440	MCK40927901	Cover, MOLD ABS HF-350 Wx42 ABS HINGE COVER
910	MCK40928201	Cover, MOLD ABS HF-350 Wx42 ABS Stand body
920	AAN35581001	Base Assembly, BASE W1942, W2042 AB W1942, W2042 BASE ASM
200	EAJ36290801	LCD,Module-TFT, LM190WX1-TLC1 DRIVER 19INCH 1440X900 300CD COLOR 72% 16/10 850:1 5ms, MAGNA source D-IC, OKI gate D-IC, TLI T-con, 160/160, P7 LG PHILIPS LCD
	or EAJ36290802	LCD,Module-TFT, LM190WX1-TLC2 DRIVER 19INCH 1440X900 300CD COLOR 72% 16/10 850:1 P7,5ms,Non-ZBD,MAGNA source D-IC, OKI gate D-IC, TLI T-con, 160/160 LG PHILIPS LCD
330	EBR41617001	PCB Assembly, CONTROL T.T LM73A BAIKAL 3 19-INCH RD -
450	EBU41912301	Main Total Assembly, BAIKAL III MSTAR ANALOG BRAND LM73B
460	△ EBR36269403	PCB Assembly,Power, POWER T.T LM-57C BAIKAL II - -

THE Δ SYMBOL MARK OF THIS SCHEMATIC DIAGRAM INDICATES SPECIAL FEATURES IMPORTANT FOR PROTECTION FROM X-RADIATION. FILE AND ELECTRICAL SHOCK HAZARDS. WHEN SERVICING IT IS ESSENTIAL THAT ONLY MANUFACTURERS SPECIFIED PARTS BE USED FOR THE CRITICAL COMPONENTS IN THE Δ SYMBOL MARK OF THE SCHEMATIC.

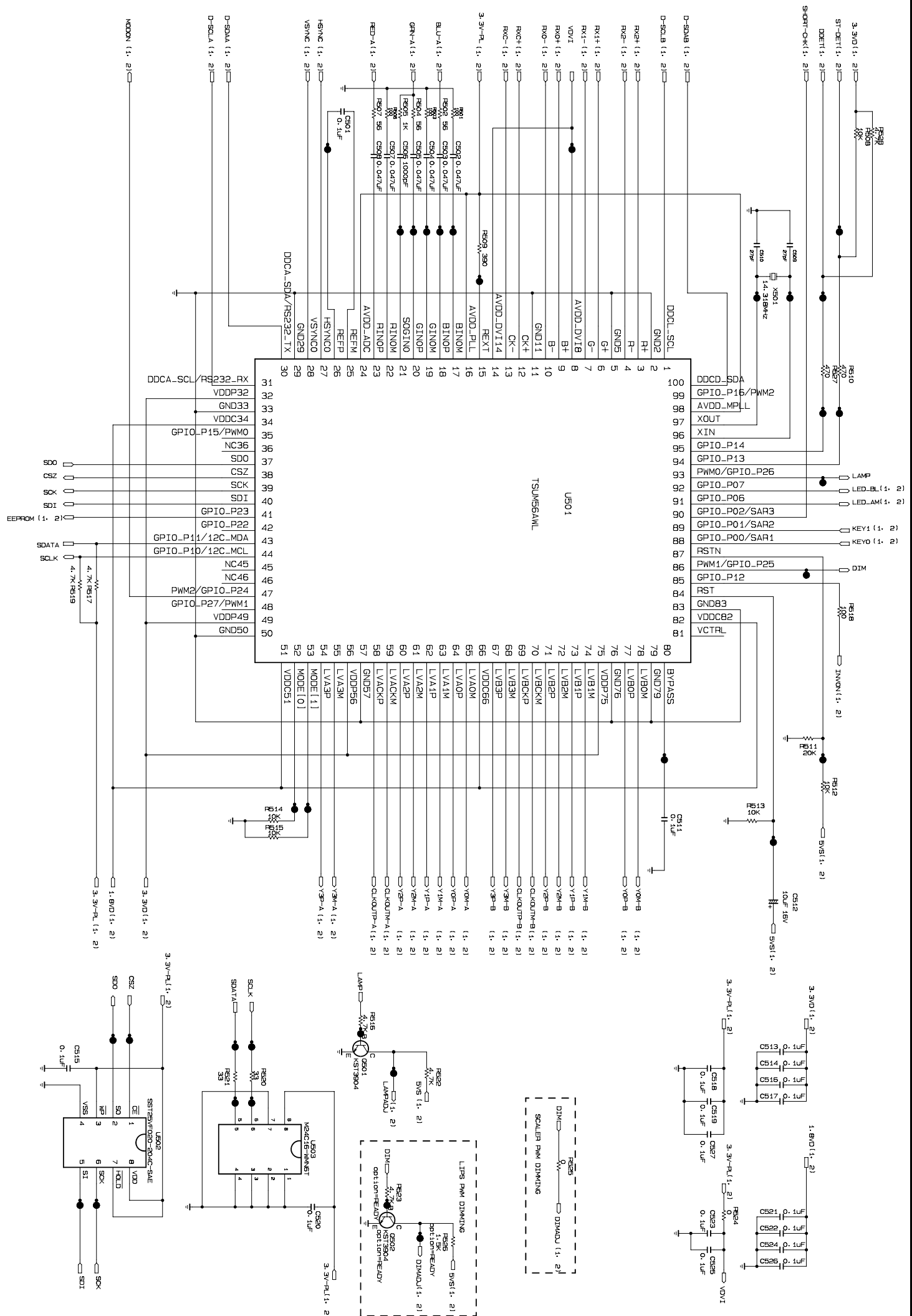

MODEL	BAIKAL III MSTAR	DATE	2007-10-17
BLOCK	SCALER	SHEET	1 / 2

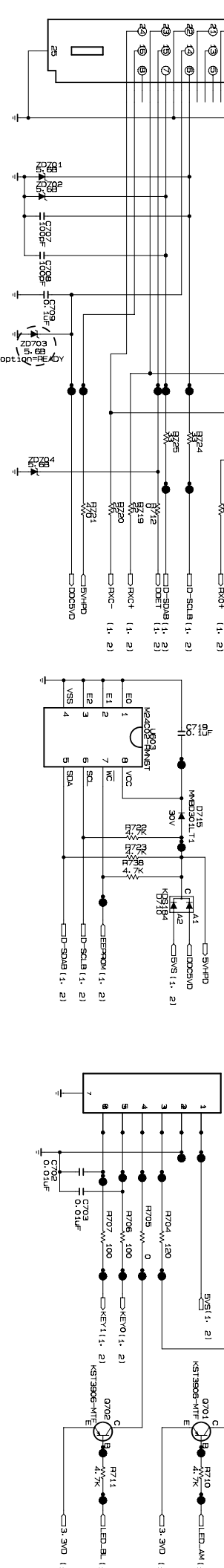
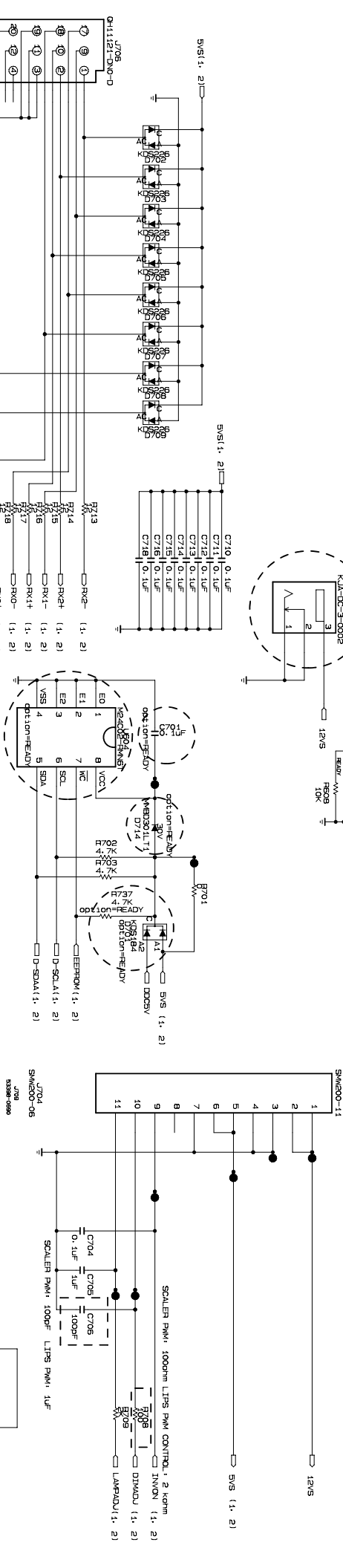
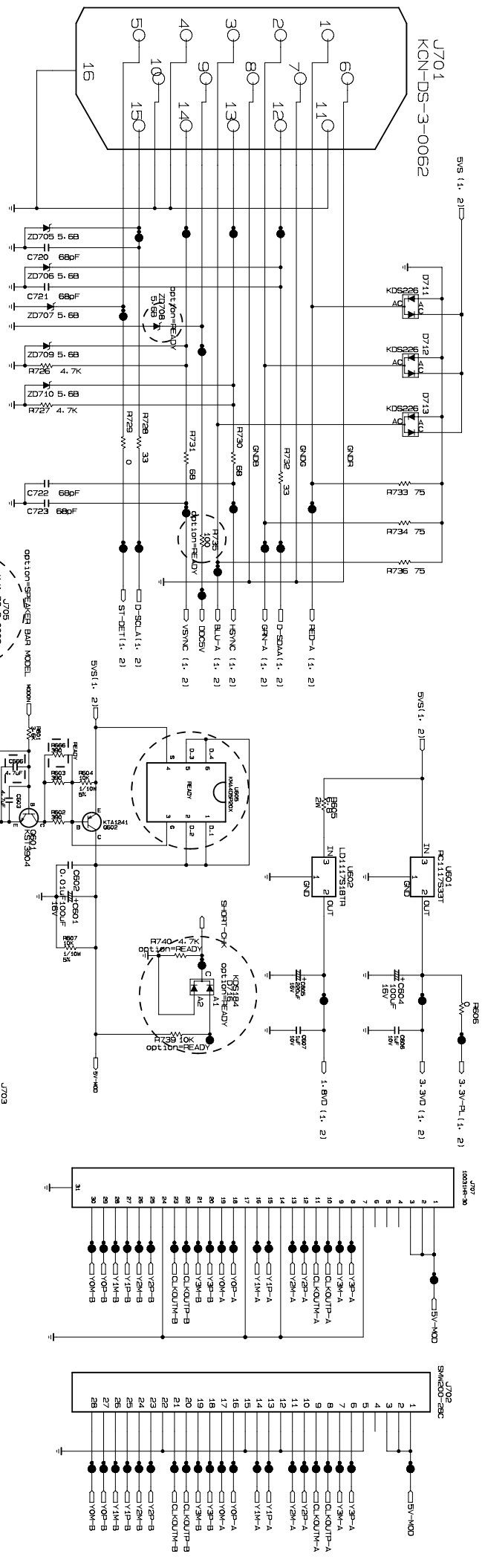

THE Δ SYMBOL MARK OF THIS SCHEMATIC DIAGRAM INDICATES SPECIAL FEATURES IMPORTANT FOR PROTECTION FROM X-RADIATION. FILE NO. AND ELECTRICAL SHOCK HAZARDS, WHEN SERVICING IT IS ESSENTIAL THAT ONLY MANUFACTURERS SPECIFIED PARTS BE USED FOR THE CRITICAL COMPONENTS IN THE Δ SYMBOL MARK OF THE SCHEMATIC.



MODEL	BAIKAL III MSTAR	DATE	2007-10-17
BLOCK	POWER & WATER	SHEET	2 / 2

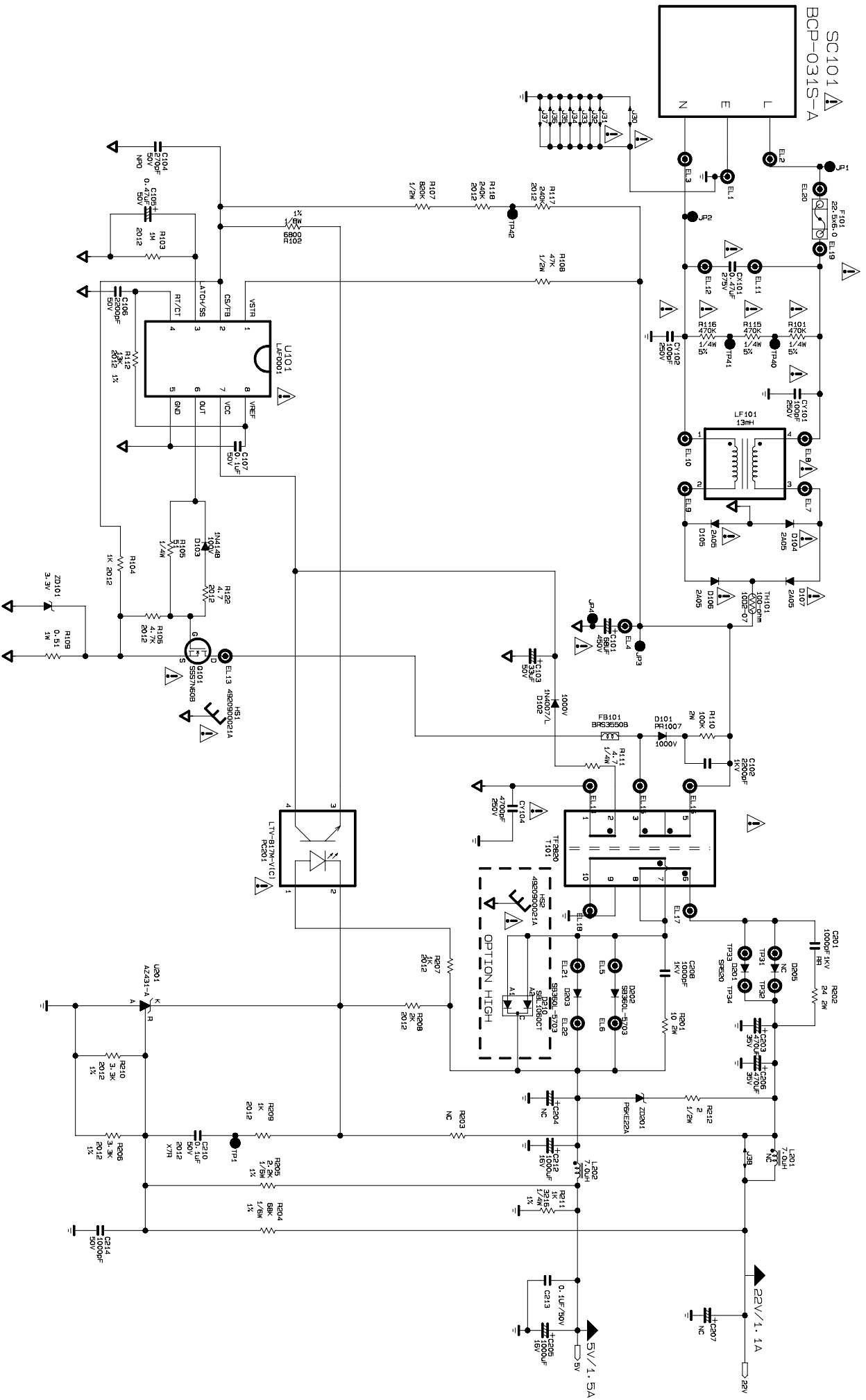

THE SYMBOL MARK OF THIS SCHEMATIC DIAGRAM INCORPORATES
 SPECIAL FEATURES IMPORTANT FOR PROTECTION FROM X-RADIATION,
 FIRE AND ELECTRICAL SHOCK HAZARDS, WHEN SERVICING. IF IT IS
 ESSENTIAL THAT ONLY MANUFACTURERS SPECIFIED PARTS BE USED FOR
 THE CRITICAL COMPONENTS IN THE SYMBOL MARK OF THE SCHEMATIC.



MODEL	BAIKAL 3 LIPS (LOW)	DATE	2007/08/28
BLOCK	POWER	SHEET	1 / 2

PCB P/N : EAX40312101

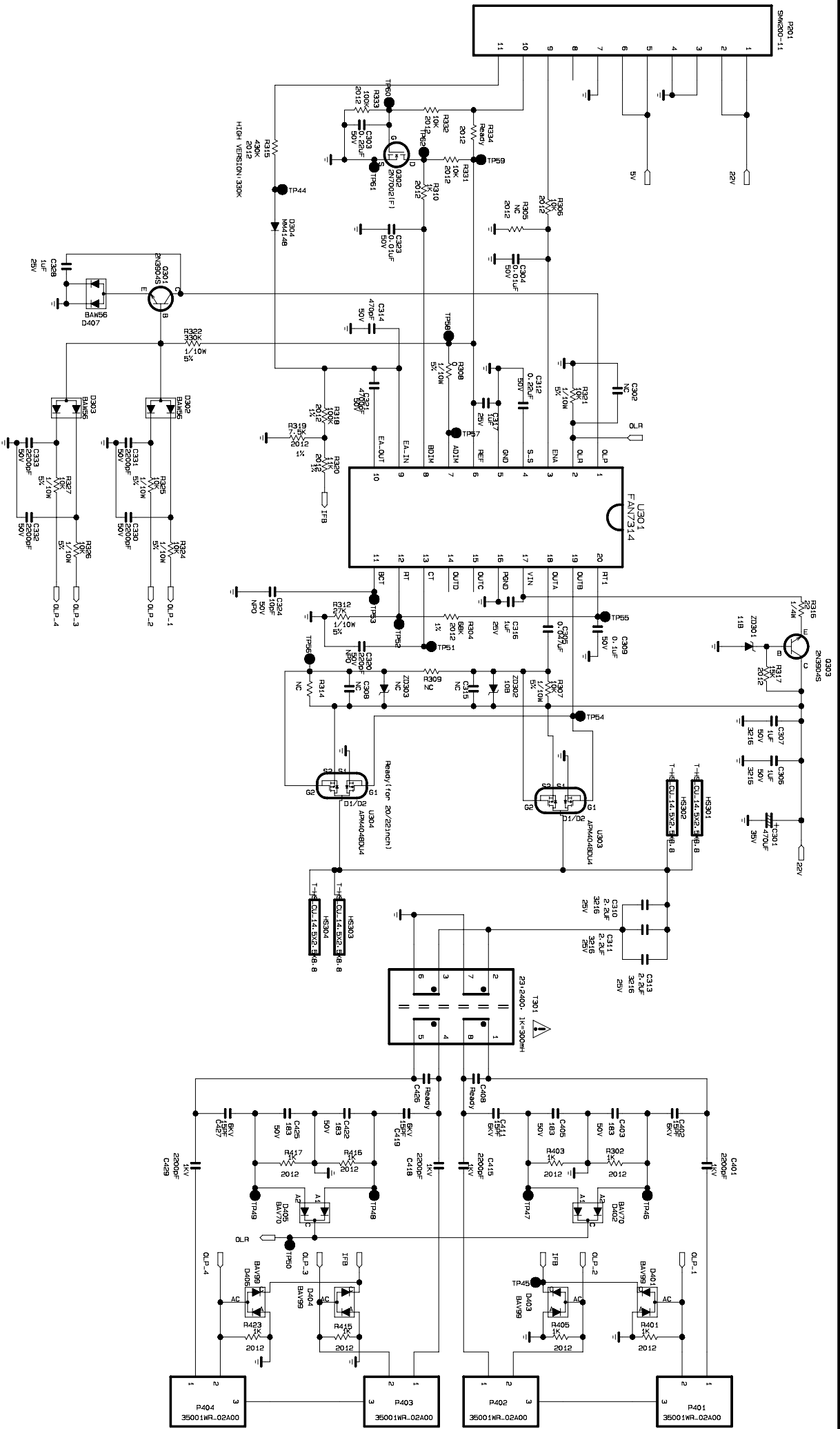

THE  SYMBOL MARK OF THIS SCHEMATIC DIAGRAM INCORPORATES SPECIAL FEATURES IMPORTANT FOR PROTECTION FROM X-RADIATION, FIRE AND ELECTRICAL SHOCK HAZARDS, WHEN SERVICING. IT IS ESSENTIAL THAT ONLY MANUFACTURERS SPECIFIED PARTS BE USED FOR THE CRITICAL COMPONENTS IN THE  SYMBOL MARK OF THE SCHEMATIC.

 LG ELECTRONICS

MODEL
BLOCK

BAIKAL 3 LIPS(LDM)

DATE
SHEET

2007/08/28
2 / 2

PCB P/N : EAXX40312101

00V201WR1005E P401 3500µF 250V
00V201WR1005E P403 3500µF 250V
00V201WR1005E P402 3500µF 250V



P/NO : MFL32179251

MAR. 2008
Printed in China